

Introducing the RGS Series

The Industry's Most Flexible, High Performing, and Intelligent Regenerative Grid Simulator



up to 21kVA in 4U



Regenerative

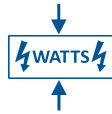

Power Density

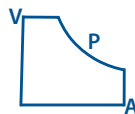

Constant Power



High Current



Grid Compliance Test

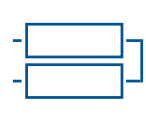

Scalable Power

Key Features

- Regenerative Grid Simulator
 - » 4-Quadrant AC & DC Power Source
 - » AC/DC Electronic Load Option
- High Power Density – Up to 21kW in 4U; Parallel up to 189kW per cabinet, or Dual cabinets up to 252kW
- Three-Phase High Power System configurations up to 756kW
- AC, and DC Output Capability, optional AC+DC mode
- Single, Split, Three-Phase; Multi-Channel Mode
 - » Isolated Neutrals Available (Option W)
- Constant Power Voltage Range: 350Vac L-N/606Vac L-L or $\pm 500Vdc$
- High Frequency Range 15Hz - 200Hz
- Full Galvanic Isolation from Facility AC Input to Output and Between Output Phases / Channels
- Dynamic, Quiet and Efficient Operation
- Advanced Silicon Carbide (SiC) Based Technology
- High AC Current Range
- Waveform Capture and Scope Display
- Powerful Line Disturbance Tools
 - » Generate Harmonics and Interharmonics
 - » Analog I/O Signals Standard
- Intuitive User Interface with Multiple Control Options
- **SmartSource Suite:** Web Browser Control

'2-in-1' RGS Series

Regen Grid Simulator & Load up to 756kW

The RGS Regenerative Grid Simulator with AC/DC Load Option is designed to emulate real-world grid connections for testing EV, Solar PV inverters and smart-grid applications. Its high-power density provides 12kVA/kW up to 21kVA/kW in a 4U chassis and can parallel up to 189kVA/kW in a single 19" cabinet. Dual cabinets can parallel up to 252kVA/kW. Three-Phase High Power System configurations up to 756kW

The RGS Series is modular by design and scalable in power. Its flexible channel outputs and advanced control and programming capabilities make it ideal for generating complex user-defined waveforms. Full operator control of power, frequency and phase angle settings allows for testing a wide range of grid-tied products. Easily test your UUT to regulatory compliance standards such as IEEE 1547, UL 1741, IEC 61000-3, IEC 61000-4, and more.

Application Examples:

- EV Charging, On Board Chargers (OBC), Wallboxes, V2G, V2H, V2X, and EV Charging Cables
- Solar PV/Grid-Tied Inverters; Smart Grid Simulation
- Energy Storage Systems (ESS); Home ESS
- UPS Products and PDUs
- IEC Compliance Testing
- Bidirectional Applications (e.g. motors) to address back EMF



Flexible Control

Constant Power Voltage Range

The RGS Series uses a single, constant power voltage range for both higher current at lower voltage and higher voltages at lower currents eliminating the need to switch between voltage ranges.

The RGS's constant power voltage range allows for testing a broad range of conditions and test requirements without interruption of output power.

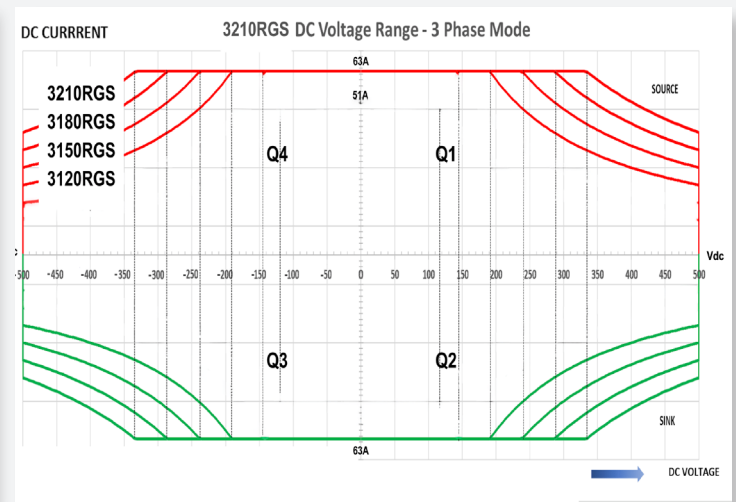
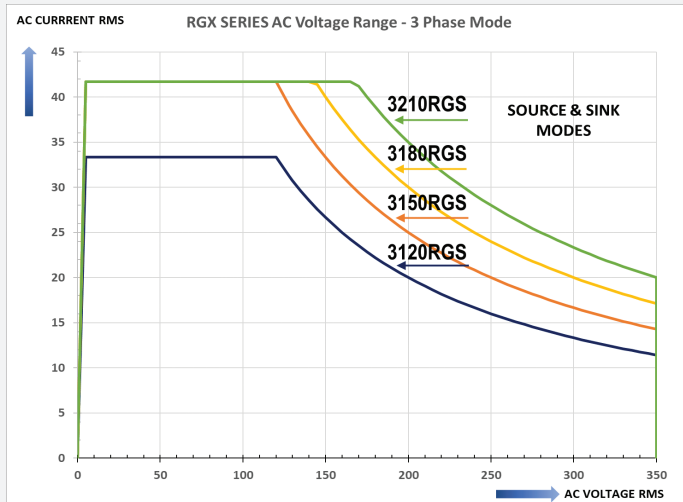

More Current at Low Voltage

The RGS provides a broader range of current eliminating the risk of over or under sizing the power source.

- Higher RMS current rating at lower voltage settings
- No over or over size AC Source to achieve required current levels
- Reduces capital investment
- Test Constant Power AC input products down to lowest rated input voltage

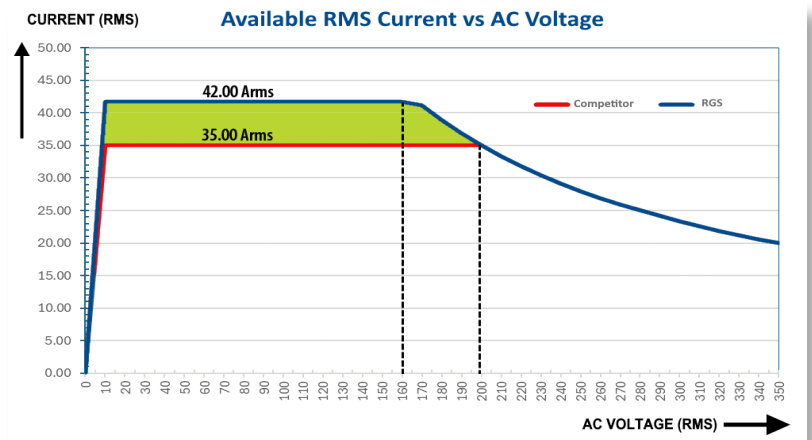

The RGS provides 20% more current from 120V to 200V compared to a typical unit that maxes out at 35A/phase.

130% Overload Capability for 2s

The RGS Series is designed to handle overload conditions with its capability of providing 130% of its rated current for a duration of 2 seconds. This is critical for applications that have inrush current conditions that arise due to start up, transient power demands, or sudden changes in loads. Applications include motors drives, industrial automation, and power conversion applications.

Test Impacts of Microgrid & DER on the Grid

The RGS Series is ideal for testing regenerative and or bidirectional applications. Regenerative AC & DC power sources provide energy efficiency and significant cost savings by returning energy back to the facility or the grid. Regenerative bidirectional power flows are critical for simulating real-world conditions in transportation and renewable energy systems. Bidirectional power flows are also critical to prevent back-EMF in applications such as motors.



Ultimate Flexibility With Six Output Configurations

Flexibly test a wide range of grid-tied conditions and EUTs with six different output configurations in either AC, DC; source or load mode. Isolated neutrals enables operation on each phase as a different function: voltage source, current source, or load (option).

- Forms 1 through 3 are common for single, split or three-phase AC connections.
- Forms 4 through 6 allow for two or three EUTs' to be tested with the same AGX source or load.

This means that three independent single-phase 7 kW EUT's could be tested simultaneously using a single 21kW AGX unit.

- Form 5 supports different frequencies on each phase simultaneously.

Simultaneous AC & DC Operation on Single Phases and Automatic Switching of Operation Modes

	FORM 1	FORM 2	FORM 3	FORM 4	FORM 5	FORM 6
Phase A		SPLIT PHASE		ONE PHASE A	ONE PHASE A	SPLIT PHASE
Phase B	ONE PHASE		THREE PHASE	ONE PHASE B	ONE PHASE B	
Phase C					ONE PHASE C	ONE PHASE C

Mixed Source / Load mode combinations available in Forms 4, 5 and 6.

Powerful Waveform & Measurement Tools

The RGS Series has a built-in waveform digitizer with scope function.

- Fast transient capabilities at **200µsec** time resolution
- LIST, PULSE and STEP Transients
- Over 200 Arbitrary Waveform
- 10 Standard, Sine, Square, Triangle, Clipped
- Includes both **Harmonics AND Interharmonics** generation
- **Pre-written test standards** for grid compliance testing (Option)

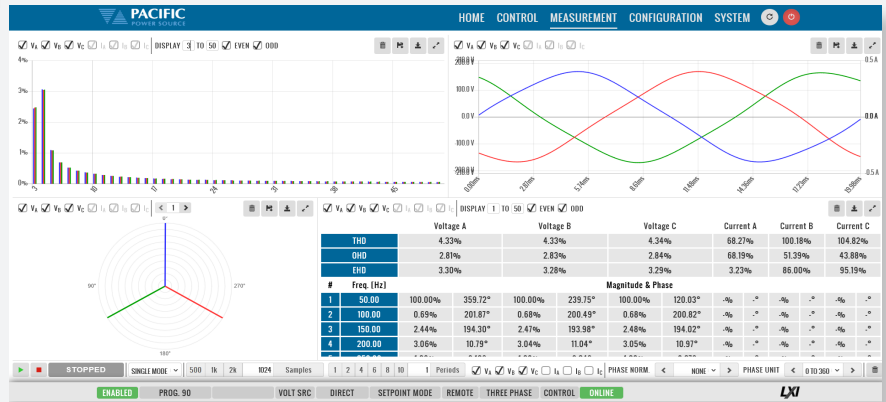

Easily Generate Harmonics & interharmonics

Fully Test AC Power with 4-Quadrant Load (Option L)

Optional load feature supports testing PV inverters, V2G, EV Chargers, EVSE, batteries, UPS, and AC/DC power supplies.

Fully operate in all four quadrants using programmable phase shift in CC or CS modes. This allows simulation of inductive and capacitive loads to fully test AC power sources, as shown in the leading and lagging power factor examples.

Simulate AC/DC linear and non-linear loads (rectified), inductive and capacitive loads with several operating modes.

AC Modes: Constant Current, Constant Power & Apparent Power, Constant Resistance, Constant Voltage, CC+CR, CC / CS Rectifier Mode 1Ø & 3Ø

DC Modes: Constant Current, Constant Power, Constant Resistance, Constant Voltage, CR+CC

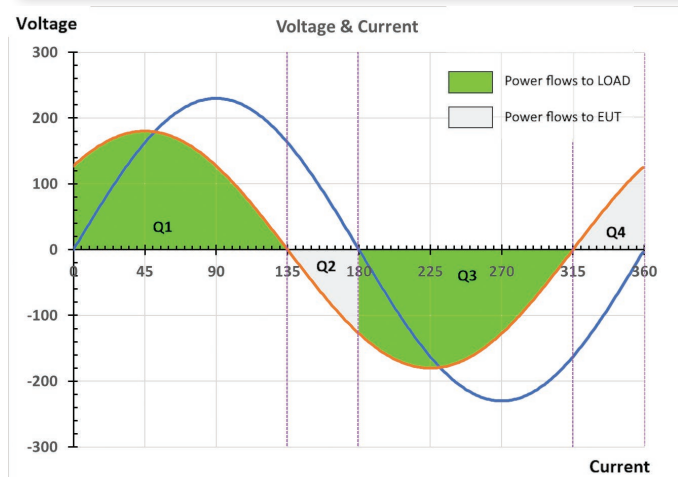
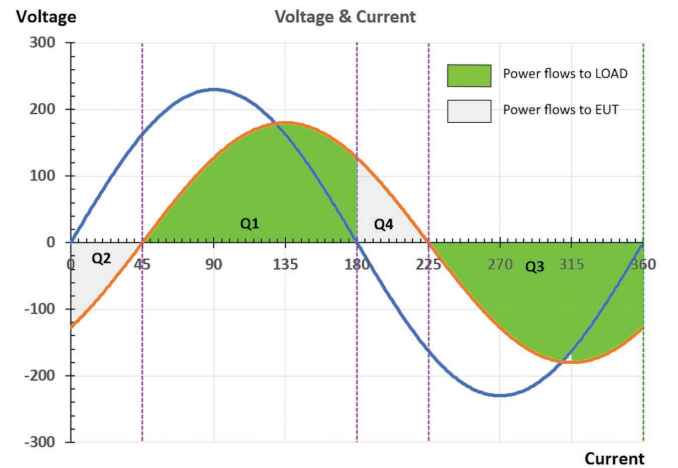

User Friendly Control Options

Multiple Control Options

- Intuitive Touch Screen LCD Display with Soft Key driven Menus
- **SmartSource Suite** Web Interface
- LAN, GPIB, RS232 & USB Interfaces, and ModBus (optional)
- Supports external touch screen monitor via Video Output Interface



Simplify Test Automation with SmartSource Suite Remote Control Platform

Easily monitor, control, and manage testing with the RGS's SmartSource Suite remote control platform. Use the embedded, web browser interface with real-time control. Access control panels and test sequences on-premises or on any mobile device (laptop, phone, tablet) via secure client access.

- Full control and measurement capability
- Program settings and measurement read back including digital scope and harmonics data
- Extensive safety protection settings
- Waveform selection, preview and edit modes
- Execution of user's custom test sequences
- Transient data entry and execution screen using a spreadsheet layout

Built-in Galvanic Isolation Reduces Safety Risks

The RGS provides both facility-to-output isolation, and phase to phase or channel to channel isolation. Galvanic isolation provides complete separation between the input and output so there is no electron flow between channels.

- Channel to channel isolation provides flexibility to use each phase as its own independent power source with FULL frequency and voltage control.
- Fully isolated design reduces safety risks for the operator and prevents unexpected UUT damage by preventing unwanted current or ground loops. This built-in capability doesn't require a transformer which saves significant costs and space.

Modular Power up to 189kW / 378A per Cabinet

The RGS Series provides modular and scalable power to meet changing test requirements. Easily parallel multiple chassis to reach up to 189kW with 378Amps per cabinet. Cabinets can be paralleled up to 252kW. Three-Phase High Power System configurations available up to 756kW.

- Ease of reconfiguration allows for flexible test set ups and reduces downtime for repairs or maintenance
- Flexibility to scale power now or later as you need it
- Paralleled units can have different power ratings
- Auxiliary no-controller models offer low-cost option
- Complete integrated 19" Rack systems available. Select from 18U, 32U, and 42U cabinets
- **Parallel configuration kits available** for system integrators using their own cabinets

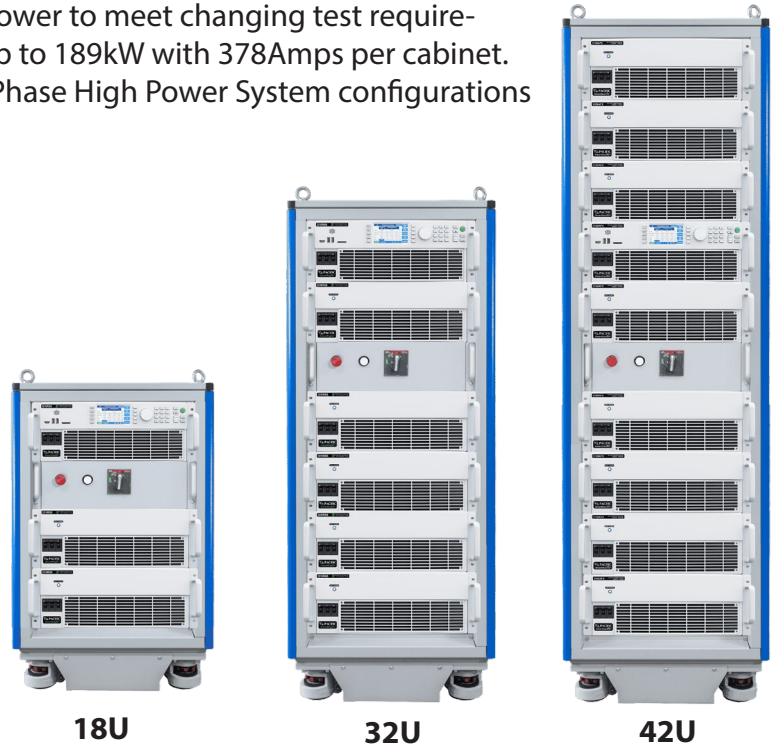

Parallel Systems Installed in 19" EIA Rack Cabinet

MODE	Rated Power ¹ AC / DC mode	Voltage Ranges ² Vac L-N / Vdc	Max. AC/DC Current per phase in 3 & 2 Phase Mode	Rack Space
3240RGS-4U	24 kVA, kW / 24 kW	0-350 Vac / 0-500 Vdc	68.0 Arms / 42.0 Adc	18U
3300RGS-4U	30 kVA, kW / 30 kW	0-350 Vac / 0-500 Vdc	84.0 Arms / 42.0 Adc	18U
3360RGS-4U	36 kVA, kW / 36 kW	0-350 Vac / 0-500 Vdc	84.0 Arms / 42.0 Adc	18U
3420RGS-4U	42 kVA, kW / 42 kW	0-350 Vac / 0-500 Vdc	84.0 Arms / 42.0 Adc	32U
3630RGS-4U	63 kVA, kW / 63 kW	0-350 Vac / 0-500 Vdc	126.0 Arms / 63.0 Adc	32U
3840RGS-4U	84 kVA, kW / 84 kW	0-350 Vac / 0-500 Vdc	168.0 Arms / 84.0 Adc	32U
31050RGS-4U	105 kVA, kW / 105 kW	0-350 Vac / 0-500 Vdc	210.0 Arms / 105.0 Adc	32U
31260RGS-4U	126 kVA, kW / 126 kW	0-350 Vac / 0-500 Vdc	252.0 Arms / 126.0 Adc	32U
31470RGS-4U	147 kVA, kW / 147 kW	0-350 Vac / 0-500 Vdc	294.0 Arms / 147.0 Adc	42U
31680RGS-4U	168 kVA, kW / 168 kW	0-350 Vac / 0-500 Vdc	336.0 Arms / 168.0 Adc	42U
31890RGS-4U	189 kVA, kW / 189 kW	0-350 Vac / 0-500 Vdc	378.0 Arms / 189.0 Adc	42U
32100RGS-4U	210 kVA, kW / 210kW	0-350 Vac / 0-500 Vdc	420.0 Arms / 210.0 Adc	2 x 32U
32310RGS-4U	231 kVA, kW / 231 kW	0-350 Vac / 0-500 Vdc	462.0 Arms / 231.0 Adc	2 x 32U
32520RGS-4U	252 kVA, kW / 252kW	0-350 Vac / 0-500 Vdc	504.0 Arms / 252.0 Adc	2 x 32U

Three-Phase High Power System configurations are available up to 756kVA/kW; contact Factory for details.

Note 1: For Split Phase mode, rated power is 2/3.

Note 2: For Voltage ranges above 333Vac some frequency and Vthd restrictions apply.

Contact factory for cabinet output wiring modifications to support single phase AC mode on cabinets above 84

Parallel configuration kits available for system integrators using their own cabinets.

Technical Specifications

MODEL:	3120RGS-4U	3150RGS-4U	3180RGS-4U	3210RGS-4U
Modes of Operation: Regenerative Grid Simulator, Regenerative DC Power Source. Regenerative Electronic Load optional.				
AC or DC Output				
Phase Modes (Form)	1, 2 or 3	1, 2 or 3	1, 2 or 3	1, 2 or 3
Maximum Power (Total)	12 kW/kVA	15 kW/kVA	18 kW/kVA ¹	21 kW/kVA ¹
Per Phase / Channel	4 kW/kVA	5 kW/kVA	6 kW/kVA	7 kW/kVA
DC Offset	< 20 mV			
Output Noise (DC – 300 kHz)	< 150 mV rms			
Voltage				
Range ²	AC Range: 0 - 350 V _{LN} / 0 - 606 V _{LL} DC Range: 0 - ±500 V _{DC}			
Resolution	0.01		Accuracy:	± 0.25% F.S
Harmonic Distortion R Load	< 100 Hz < 0.3% 100 Hz to 500Hz < 0.5% 500 to 1000 Hz < 1.0% > 1000 Hz < 1.5%			
Line Regulation	< 0.1% for 10% Line Change			
Load Regulation	± 0.02% (CSC Mode)			
Phase Angle - Range (B, C)	0 - 359.9°		Resolution:	0.1°
Maximum Current				
3 & 2 Phase modes AC / DC	34.0 ARMS / 16.7 ADC	42.0 ARMS / 21.0 ADC	42.0 ARMS / 21.0 ADC	42.0 ARMS / 21.0 ADC
1 Phase mode AC / DC	100.0 ARMS / 50.0 ADC	126.0 ARMS / 63.0ADC	126.0 ARMS / 63.0ADC	126.0 ARMS / 63.0ADC
Current Crest Factor (AC)	3.0 : 1		2.5 : 1	
Frequency				
Range	15.00 – 200.0 Hz std or 15.00 - 1200Hz Option F		Resolution / Accuracy:	0.01 Hz / ± 0.01%
AC Input				
Input Voltage Range / Freq	380Vac – 480Vac ± 10%, 4 Wire, L1, L2, L3 and PE / 47 - 63 Hz			
Nom. Phase Current @ 400Vac / 480Vac	21 Arms / 18 Arms	26 Arms / 22 Arms	31 Arms / 26 Arms	36 Arms / 30 Arms
Input Power Factor	0.99		Efficiency:	0.85
Measurement				
Vrms Range / Accuracy	0 – 350 V _{LN} / 0-606 V _{LL} / ± 0.25% F.S.			
Irms Range ³ / Accuracy	34.0 A / ± 0.5% F.S.	42.0 A / ± 0.5% F.S.	42.0 A / ± 0.5% F.S.	42.0 A / ± 0.5% F.S.
Power Range ³ / Accuracy	4 kW / ± 1.5 % F.S.	5 kW / ± 1.5 % F.S.	6 kW / ± 1.5 % F.S.	7 kW / ± 1.5 % F.S.
Scope Function	Sample Rate: 54932.47 Hz / Window: 1024 Samples / Bandwidth: 1200 Hz			
Transient Functions				
Programming	200 Steps / 400 Segments, LIST, PULSE & STEP Modes, Frequency, Volt AC, Volt DC, Waveform, Ramp Time, Dwell Time. Time range: 0.1 - 10000000.0 ms, Time resolution 0.2 ms			
Execution	Run from step # to step #, Run, Step, Restart, Stop	Program Storage:	Non-volatile, 100 Programs + Transients	
PARAMETERS / FUNCTIONS SPECIFICATIONS				
Remote Control Interfaces				
USB Type B, LAN (LXI), GPIB / IEEE488, RS232, all on rear panel; External USB WIFI adapter / ModBus TCP / CAN/CAN-FD				
Analog & Digital I/O				
Analog Inputs (4) / Outputs (4)	AI1, AI2, AI3, A14 User defined functions.		AO1 AO2, AO3, AO4 User-defined measurement unctions	
Digital Inputs (6) / Outputs(6)	Remote Inhibit, Trans. Trig., Phase Sync, User		Output Relay, Transient, Function Strobe, Sync	
Environmental				
Cooling	Variable speed fan, front intake, rear exhaust		Energy Saving Modes:	Standby & Sleep
Temperature	Operating:	0 to 40 °C / 32 to 104 °F	Storage:	-20 to 70 °C/-4 to 158 °F
Humidity	< 80%, non-condensing		Altitude:	2000 m / 6500 feet
System Features				
USB Ports	2 on Front Panel, 1 on Rear Panel, All Type A		SD Card:	32 GB max. Capacity
Video Output Port	Monitor Out, Front Panel			
Dimensions & Weights				
Chassis Size H x W x D	7.0" x 17.0" x 25.0" / 178 x 432 x 635 mm		Shipping: 20" x 27" x 38" / 508 x 686 x 965 mm	
Weight Single 4U Height Unit	Net:	111.2 lbs. / 50.4 kg	Shipping:	151 lbs / 68.5 kg
Regulatory Compliance				
Safety	IEC 61010-1:2010 (Edition 3)			
EMC - Emissions / Immunity	EN 55011:2009+A1:2010 / EN 61000-4-2, -4-3, -4-4, -4-5, -4-6, -4-8 and EN 61000-4 -11			
Product Category	EN 61326-1:2013 (Measurement, Laboratory and Control Equipment)			
Agency Approvals	CE Mark, NRTL Nemko US/Canada		RoHS (2011/65/EU):	EN50581:2012

Note 1: Maximum Power rating is reduced below 40Hz on 3180RGS and 3210RGS models

Note 2: Extended Voltage Range: 0 - 365 V_{LN} / 0 - 632 V_{LL}, with V_{THD} < 1.0% @ 50~60Hz

Note 3: Measurement range is times three in single phase mode.

Ordering Information

RGS Series Model Number Encoder:

Note: Solid outlined fields must be specified. Dashed outlined fields are optional.

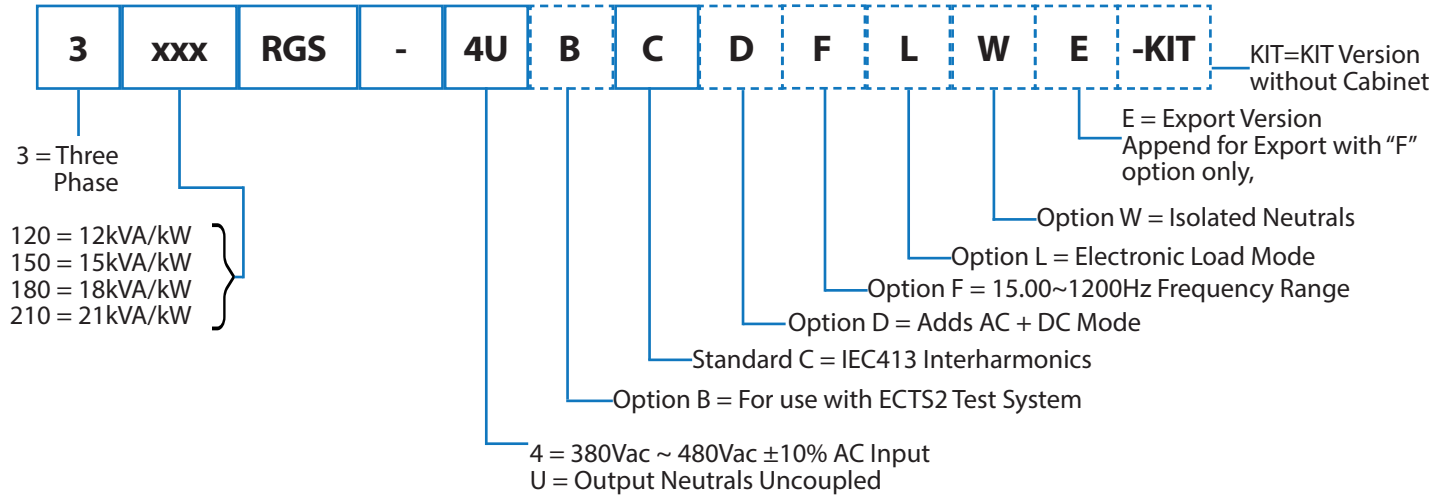

NOTE: 4U indicates that the shorting bar for output neutrals will be installed on the units by default. If Option W is selected, the units will be shipped with shorting bar for neutrals removed and provided in the ship kit instead.

Order Example: 3210RGS-4UCL	Typical Delivery Items	Available Accessories
<ul style="list-style-type: none"> Bench Model, 21 kVA, 3-Phase, Regenerative Grid Simulator with Load option, USB, RS232, LAN, GPIB & AUX I/O 	<ul style="list-style-type: none"> Power Source Rack Mount Handles Certificate of Compliance 	<ul style="list-style-type: none"> Output shorting adapter for single phase output mode use. P/N 160086 (not for W) Paralleling Cable, 1 Ft. (Included with Aux NC models). P/N 778036 Rack slides. P/N 703251
<p>Auxiliary Models (No controller) Order Example: 3210RGS-4UNC</p>		

Pre-Written Test Sequence Options

Test Sequence Options require use of built-in SmartSource Suite via LAN or USB.

- IEC Test Suite - Includes IEC 61000-4-11p, IEC 61000-4-14, IEC 61000-4-17, IEC 61000-4-27p, IEC 61000-4-28, IEC 61000-4-29p and IEC 61000-4-34
- IEC 61000-4-13 Standard
- IEEE 1547.1-2020
- Semi-F47-0706
- KS C 9610-4-11, KS C 9610-4-29
- MIL-STD 1275 Rev E

Unit Dimensions

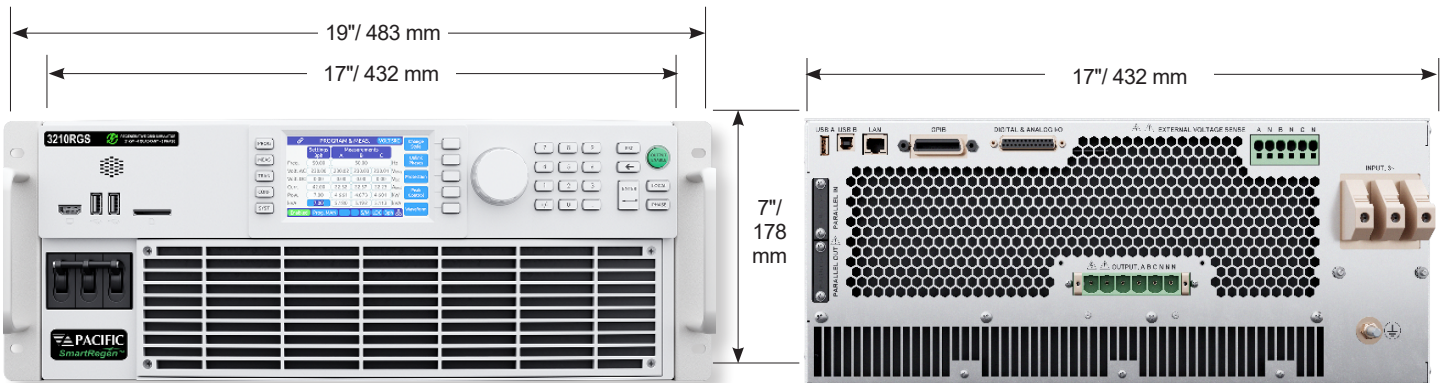

The RGS is designed for bench top or 19" equipment rack operation.

The Rear Panel provides connections for AC Input, External Sense, Aux I/O and remote control interfaces.



Innovate the Way You Test

by making it simpler, safer, more productive, and sustainable.



Global Sales & Service Centers

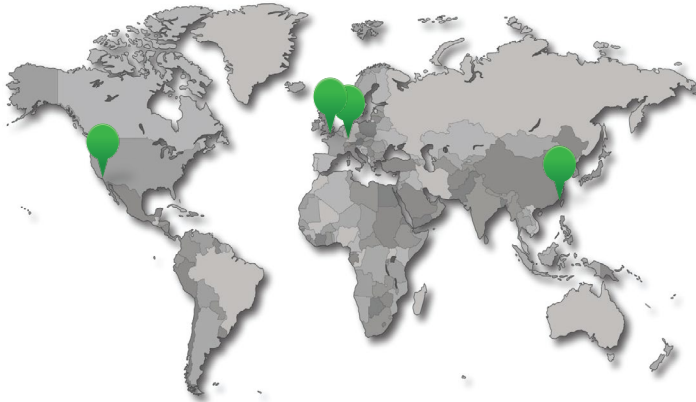

The Power of Expertise

About Pacific Power Source

Founded in 1971, Pacific Power Source is an industry leading manufacturer of AC and DC power test solutions. Our reputation as a market and technology leader stems from our best-in-class products, commitment to R&D investments, and exceptional worldwide customer support.

Pacific Power Source is a PPST Solutions Company.



Caltest Instruments GmbH

Binzigstrasse 21 | Tel: +49(0)7842-99722-00
D-77876 KAPPELRODECK | Fax: +49(0)7842-99722-29
www.caltest.de | info@caltest.de

AMERICAS & INTERNATIONAL

**Pacific Power Source
Irvine, USA**

Phone: +1(949) 251-1800
Fax: +1 (949) 756-0756
sales@pacificpower.com

EUROPE

**Pacific Power Source EU
Kappelrodeck, Germany**

Phone: +49 7842 99722-20
Fax: +49 7842 99722-29
info@pacificpower.eu

UNITED KINGDOM

**Caltest Instruments
Petersfield, UK**

Phone: +44 (0) 1483 302 700
sales@caltest.co.uk

CHINA

**PPST Shanghai
Shanghai, China**

Phone: +86-21-6763-9223
Fax: +86-21-5763-8240
info@ppst.com.cn